

FINGER PRINT WITH SMART CARD ATTENDANCE SYSTEM

FINGER PRINT WITH
SMART CARD ATTENDANCE SYSTEM
OPERATION MANUAL

STARLINK COMMUNICATION P. LTD.
A-19, OKHLA PHASE-1,
NEW DELHI

Index

Content

1. Introduction
2. Keys of smartcard with finger print machine
3. Application system modes
 - 3.1 Normal Mode
 - 3.2 Administrator Mode
4. Functionalities of keys
 - 4.1 Normal Mode
 - 4.1.1 Memory Used
 - 4.1.2 Firmware Release Date and Machine Number
 - 4.1.3 Firmware Version
 - 4.1.4 IP Address
 - 4.1.5 Netmask Address
 - 4.1.6 Gateway Address
 - 4.1.7 MAC Address
 - 4.1.8 SMART CARD –W/A
 - 4.1.9 Boot Loader
 - 4.2 Administrator Mode
 - 4.2.1 Functionalities of Key F1
 - 4.2.2 Functionalities of Key F1
 - 4.2.3 Functionalities of Key F1
 - 4.2.4 Functionalities of Key F1
5. Technical information

1. Introduction

Starlink finger print with smart card attendance system is highly technology based attendance system. When you need to take attendance, you just show the smart card from a distance of max 60 mm in front of machine and display shows that put the finger , put finger on sensor, if you r the right person, attendance will be stored in the machine. Else not matched

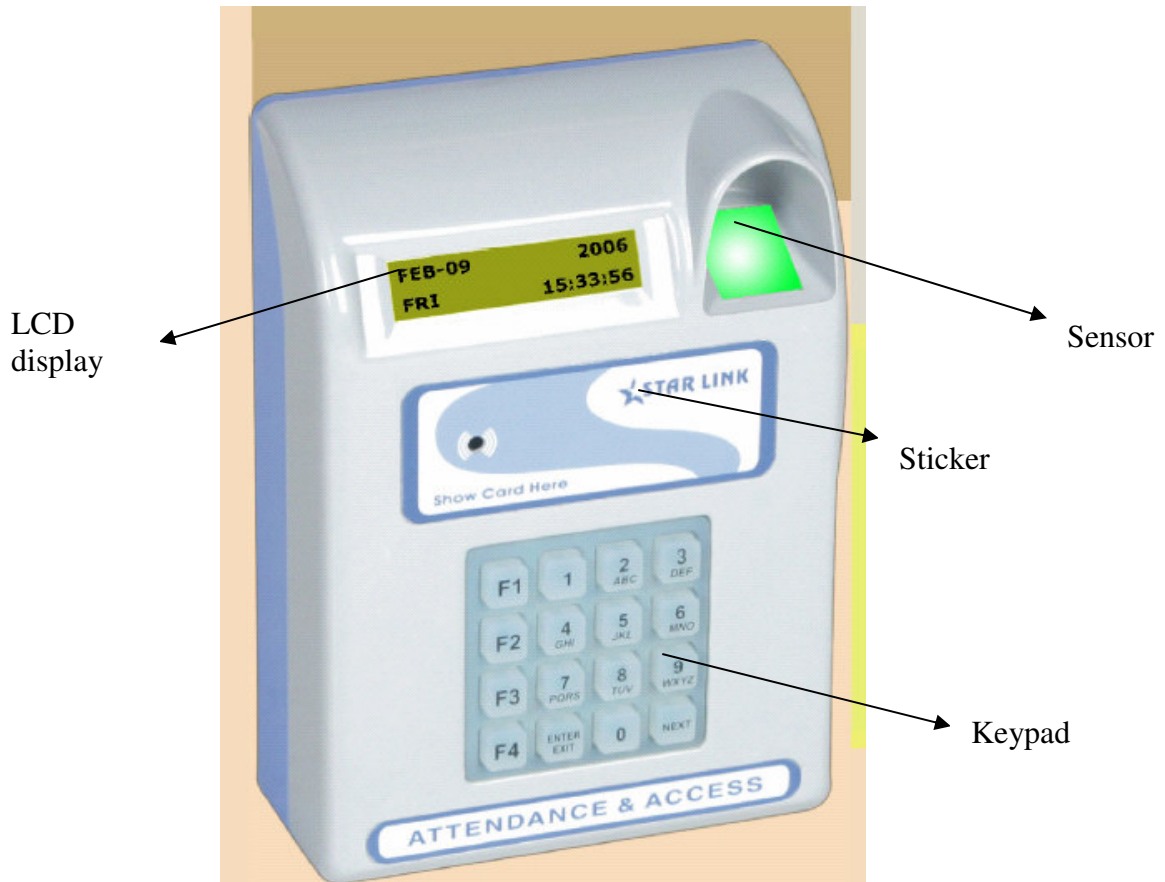

Figure -1: Smart Card with Finger Print Attendance System

Starlink attendance system is a networking based attendance system with TCP/IP protocol. Smartcard attendance has memory of mother board which is 2MB and you can store 62,500 recording in this system. You can store 2000 finger templates in the machine as well as in the computer.

2. Keys of Smartcard Machine

There are four kinds of keys in the smartcard attendance system which is give below:

F1	1	2 ABC	3 DEF
F2	4 GHI	5 JKL	6 MNO
F3	7 PQRS	8 TUV	9 WXYZ
F4	ENTER/ EXIT	0	NEXT

- Functional keys (F1, F2, F3, F4)
- Numeric keys (0 to 9)
- Enter /Exit Key
- Next key

There are total 16 keys on the key board.

3. Application system modes

There are two types of modes in smart card attendance system:

- Normal mode
- Administer mode

3.1 Normal mode

Normal mode is also known as Date Time Mode. It is a readable mode i.e. you can only read the information in this mode. In the normal mode there is only one functional key F3 which you can use.

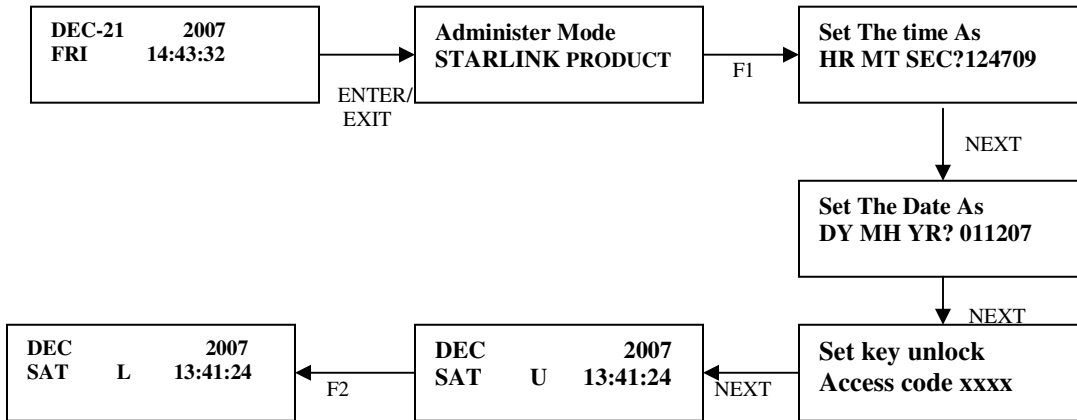

Figure 1: Sequence Operation from Normal Mode to U Mode or L Mode

You can take following steps to go to U or L mode from normal mode:

1. Date time mode
2. Press key ENTER/EXIT to switch the administer mode.
3. Press key F1 to switch for setting the time.
4. Press key NEXT to switch for setting the date.
5. Press key NEXT to switch for setting the password for unlock the access code.

6. Press key NEXT to come out in administer mode and then press key to come out in U mode.
7. Press key F2, machine will automatically switch into L mode.

3.2 Administer Mode



Press key “ENTER/EXIT” to switch from normal mode to administer mode.

4. Functionalities of Keys

Functionality of keys is discussed in both normal mode and administer mode below.

4.1 Normal Mode:

To proceed, press F3. Keys. Don't use Keys F1, F2 and F4 in normal mode.

Functionalities of key F3: Key F3 is generally used for find out the following features as Memory used, date of firmware and machine no., Firmware version, IP address, Network address, Gateway address, MAC address, Finger print limit, smart card writer, Boot loader.

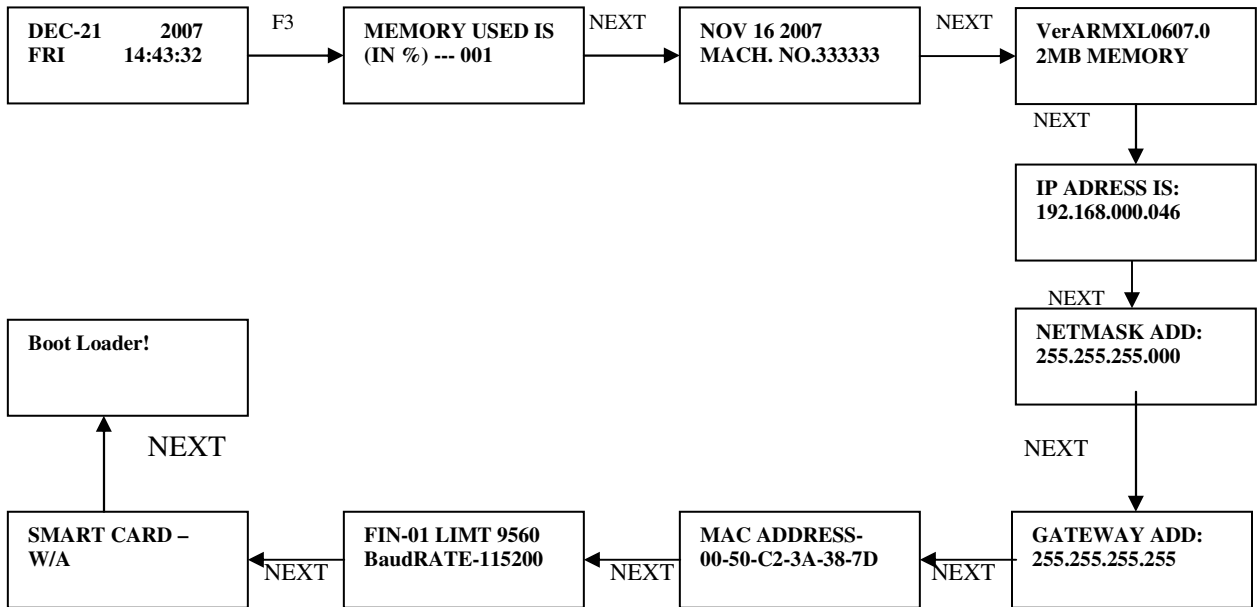
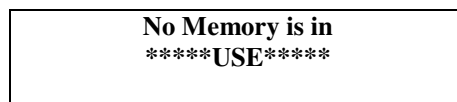

Figure 2: Sequence of Operation in Normal Mode

4.1.1. Memory Used

You can see how much percentage memory has been used in machine. If memory is empty (or no memory is used), LCD will appear as:



4.1.2. Firmware Release Date and Machine Number

You can see date of firmware and machine number of the machine.

4.1.3. Firmware Version

It shows Version of the firmware and the capacity of machine memory which is 2 MB.

4.1.4. IP Address

Starlink attendance system is a networking based attendance system with TCP/IP protocol. If you want to change IP Address, switch to functional key F2 in administer mode.

4.1.5. Netmask address

You can see the netmask address of the machine.

4.1.6. Gateway address

You can see the gateway address of the machine.

4.1.7. MAC Address

You can see the MAC address of the machine. It's is a unique address of the LAN card for every machine.

4.1.8. Finger Print Settings

FIN-01 LIMIT 1910 BaudRATE-115200

You can see the limits of finger and baud rate.

4.1.9. SMART CARD –W/A

SMART CARD is the feature of the machine. W/A stands for WRITER, which indicates smart card machine with writer facility.

4.1.10-Boot Loader

Bin file of assembling program can be uploaded through Boot loader!
Now entering 4 digits password, Machine will go to boot loader mode.
Password will be provided by starlink support engineer.

4.2 Administer mode:

You can use keys F1, F2, F3 and F4 in administer mode.

4.2.1. Functionalities of Key F1

This functional key is used for setting date, time and access code of the attendance system.

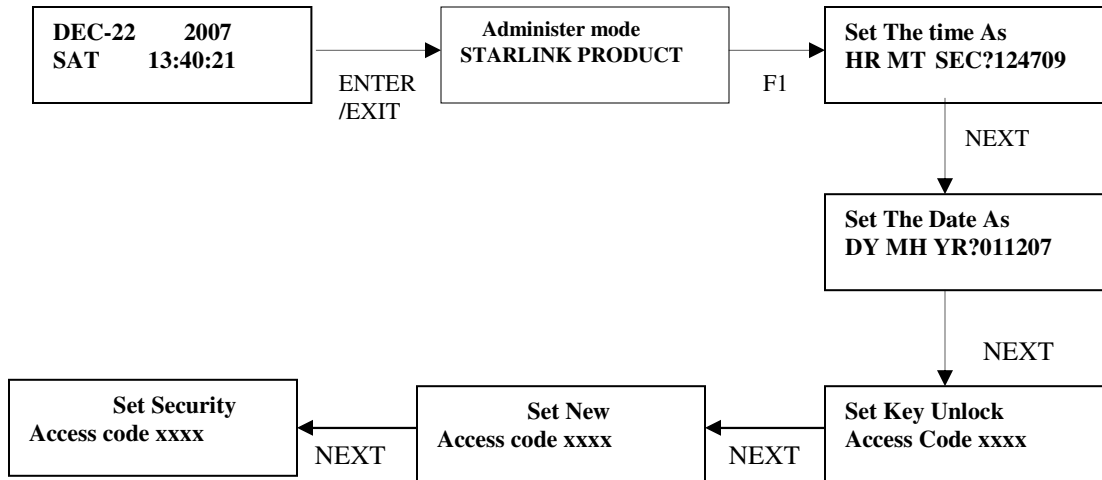

Figure 3: Sequence of Operation of Key F1 in Administer Mode

i. Set The Time

Starlink attendance system has a 24 hours mode quartz real time clock. You can set time in Hour, Minute and Second in HR MT SEC .i.e. 124709 mean 12 pm 47 min and 9 second.

ii. Set The Date

You can set date in date, month and year in DY MH YR format. i.e. 011207 means 1st Dec 2007.

iii. Set Key Unlock

Starlink attendance system has one more characteristic which is access code for security. You can set three security codes and lock the machine and nobody can operate the machine without entering these codes.

You can set access code for security to unlock the keypad in normal mode. Access code is a four digits numeric code 0-9. Access code should be neither less nor greater than 4 digits.

Note: you can see U or L mode through setting this code.

iv. New Access Code

You can set this code to lock the administer mode. Set new access code should be neither less nor greater than 4 digits. If you don't want to change the access code, just press key "NEXT".

v. Set Security Access Code

You can set this security code to access the functional keys in administer mode. Security access code should be neither less nor greater than 4 digits. After setting security access code, the system will switch to administer mode.

4.2.2. Functionalities of Key F2

This key is used to set the attendance backup for months, LCD power saving, buzzer on/off, door mode/pulse mode, email facility, ID address, netmask address, gateway address and biometric setting.

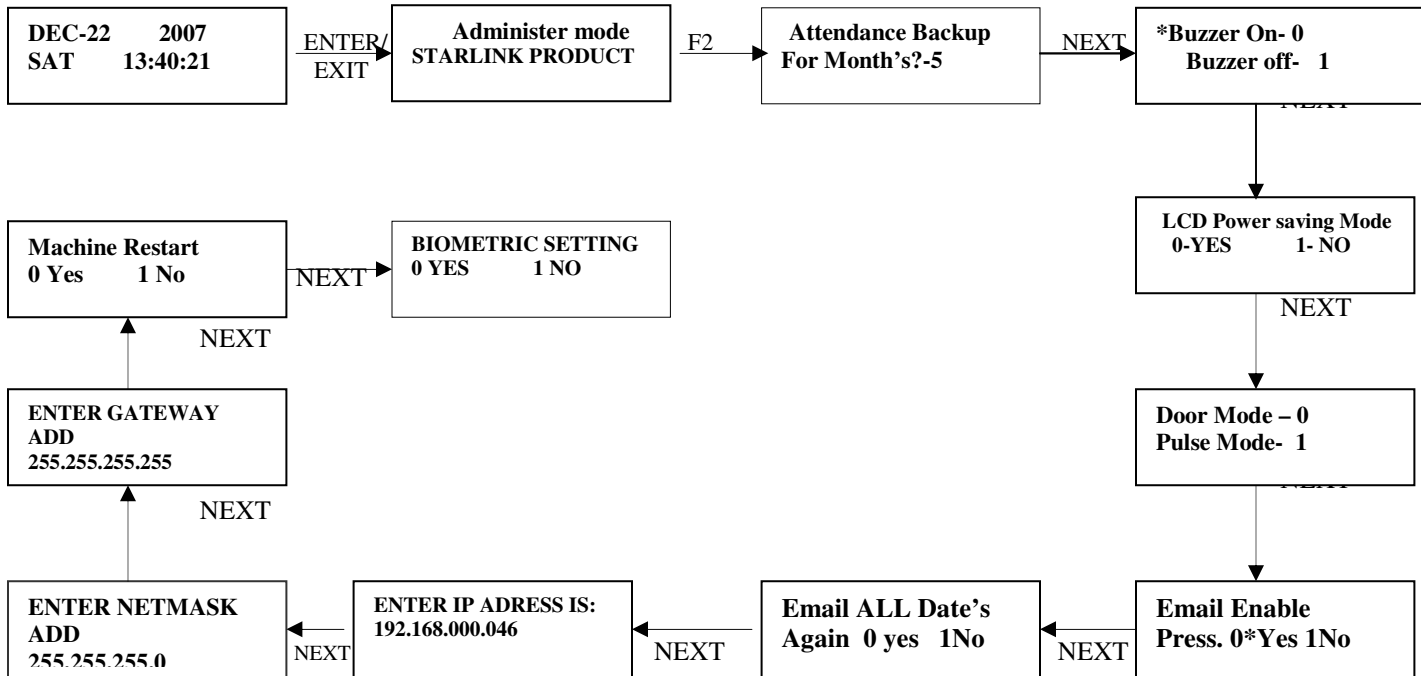

Figure 4: Sequence of Operation of Key F2 in Administer Mode

i. Attendance Backup

This function is used to take the backup of the attendance data in months. You can enter months in numeric 1 to 9.

- If you set 0 in months, it means data of attendance will be stored till then memory of system will be full and LCD display shows memory is full.
- If you set 5 in month backup of attendance will be for 5 months. After that data will automatic erase from the memory of the system.

ii. Buzzer On and Off

Starlink attendance system has a piezoelectric buzzer for keypad sound. If you want to set the buzzer of the attendance system,

- Press 1 to set the buzzer off
- Press 0 to set the buzzer on

*mark in front of buzzer indicates the active state of the buzzer (on/off)

iii. LCD Power Saving

This feature is used to save the power of the machine.

- If you press key"1", the machine will not save power. Light of LCD display will always be on.
- If you press key"0", the machine will save power. Light of LCD display will be off after duration of 3 minutes.

*mark in front of either on and off indicates the active state (on/off).

iv. Door mode/Pulse mode

You can use this option in access control process and used to connect and disconnect the electro magnetic lock.

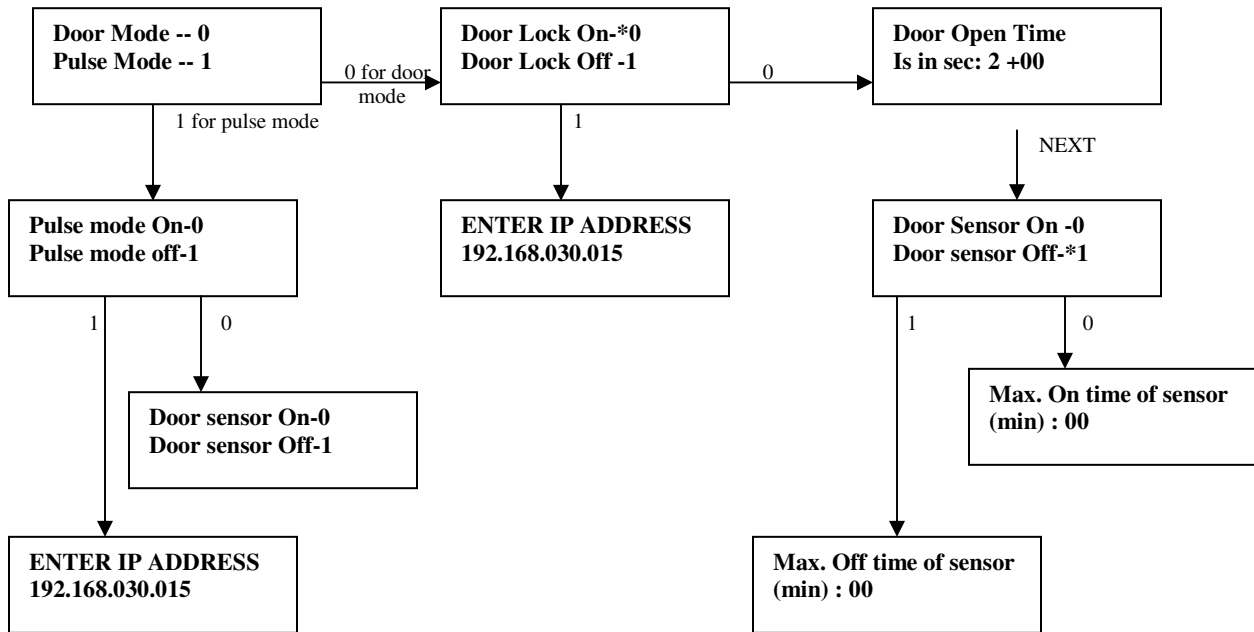

Figure 5: Sequence Operation of Door Mode and Pulse Mode.

Door mode:

- If the door lock system is on, it will ask for the Door Open Time (door open time is the time taken by the system to close the door).
- Door open time is in seconds.
- By default the door open time is 2 seconds.
- Maximum time we can set is i.e. 2+ (by default) + 99= 101 sec.

Pulse mode:

You can set a particular time of 0.5 sec in pulse mode to connect or disconnect the EM lock. It is used for tripod.

v. IP Address:

Starlink attendance systems are networking base attendance system with TCP/IP .

We can set IP address on LCD display i.e. 192.168.030.015.

- This IP address should be unique.
- Key “NEXT” is used to switch to the next number.
- To directly go to the next operation press key “ENTER/EXIT”.

vi. Netmask Address:

You can see the netmask address of the machine.

viii. Gateway Address:

You can see the gateway address of the machine.

ix. Biometric settings:

By this setting we can set security level, sensitivity level, image quality, enroll mode, displacement, free scan delay, Fast mode for 1:N search, timeout, baud rate, sensor type, finger enrolled, remaining fingers, light condition and set auto sensor.

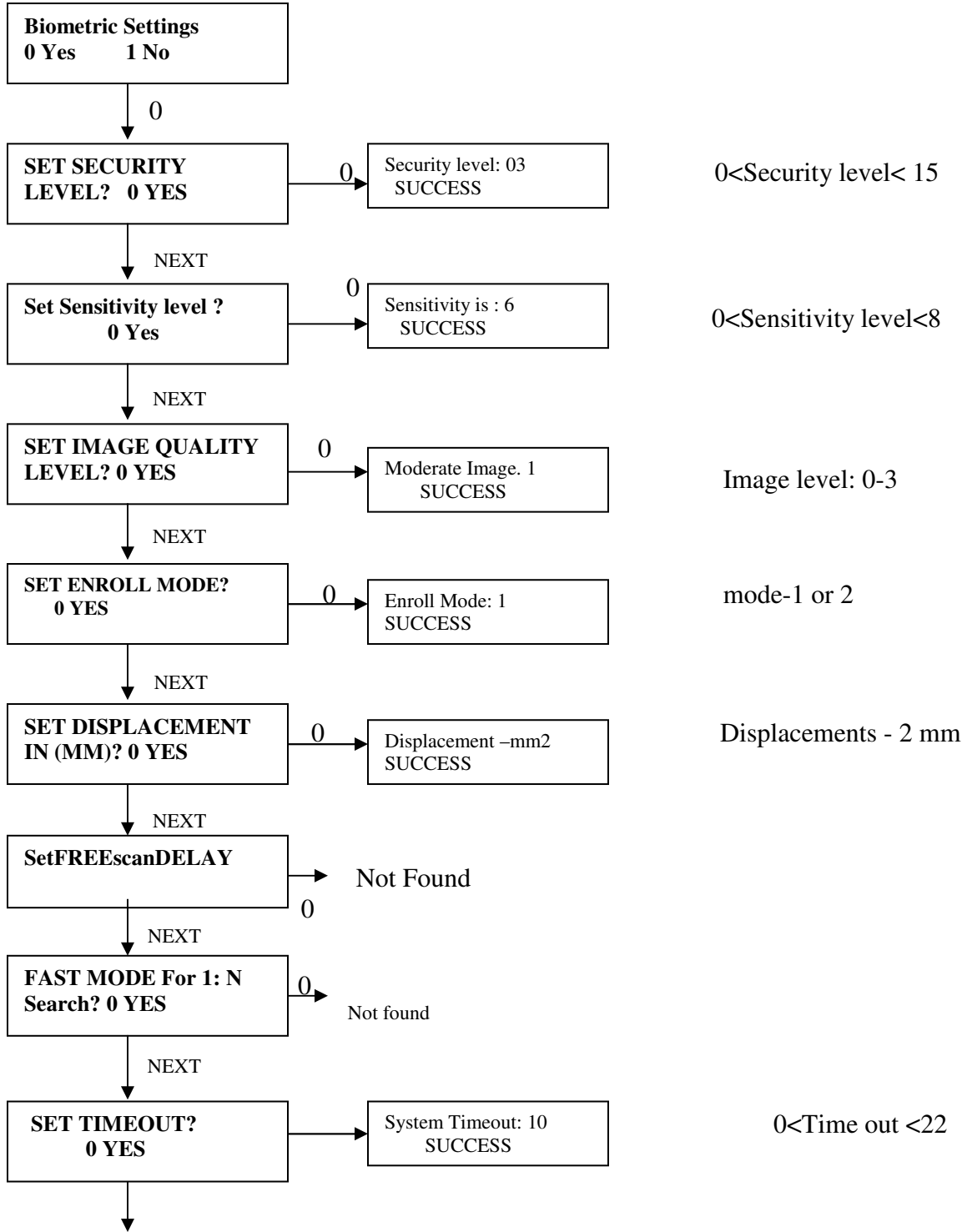

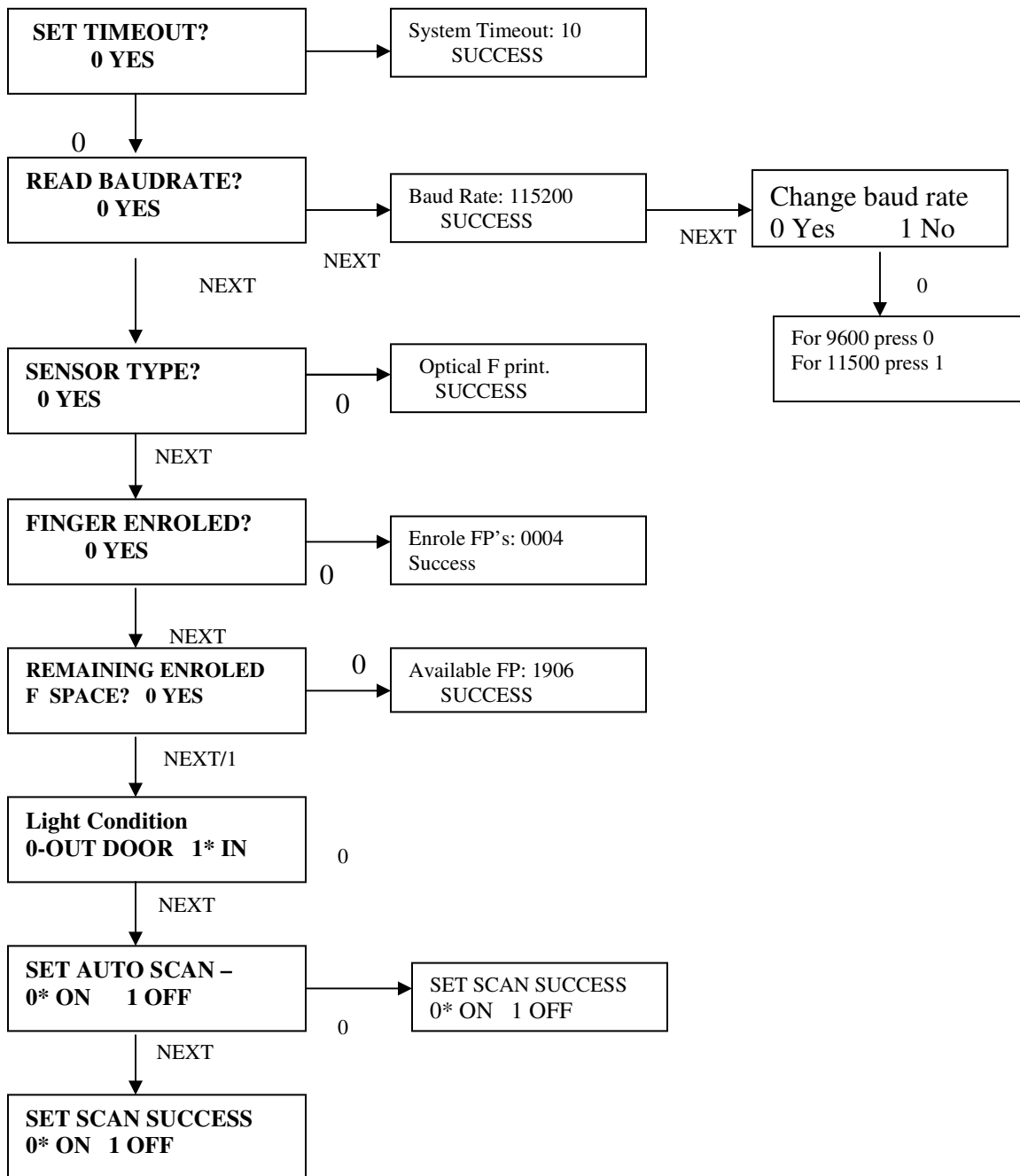

Figure 6: Sequence Operation for Biometric Setting

➤ Security Level:

You can set security level to increase the level of matching finger with another finger. Security level will vary from 0 to 15. If you set 0, finger sensor may not differentiate between different fingers. But if you increase this security level, finger sensor will be able to differentiate between different fingers.

➤ Sensitivity Level:

You can set sensitivity level of finger sensor. It will vary from 0 to 8.

➤ Image Quality:

You can set level of image quality of finger. It will vary from 0-3.

➤ **Enroll Mode:**

You can set enroll mode of the finger.

➤ **Displacement:**

You can set displacement of 2 mm. If your finger is slightly displaced on sensor, sensor will automatically capture the approximate image of the finger within the range of 2 mm.

➤ **Set Timeout:**

This option is used for smart card with finger print attendance system. If you show the card, display shows “put finger”. In that case if you didn’t put the finger within duration of 10 seconds, display shows timeout. It will vary from 0 – 22 seconds.

➤ **Baud Rate:**

Baud rate is a predefine frequency for our machine. There are two baud rate for our machine ie 9600 and 115200.

➤ **Sensor:**

You can see what type of sensor you use in finger print machine.

➤ **Finger print enrolled:**

You can see how many finger you have enrolled.

➤ **Remaining enrolled F space:**

You can see how many fingers have been left in the machine.

➤ **Light condition:**

If you put your attendance system under the light of sun, machine will work properly.

➤ **Auto scan:**

This option is used for only finger and sensor will always be on in the case of only finger print attendance system.

➤ **Scan success :**

This option is used to find/know whether the scan of the finger is successful or not while enrolling the finger. You have to set scan success always on in the case of enrolling the finger. If we set scan success off, at the time of enrolling the finger, display shows

Set Scan Success Try Again

4.2.3. Functionalities of Key F3

This key is used to reset the whole system, variable, card list and reset the punching data of the machine.

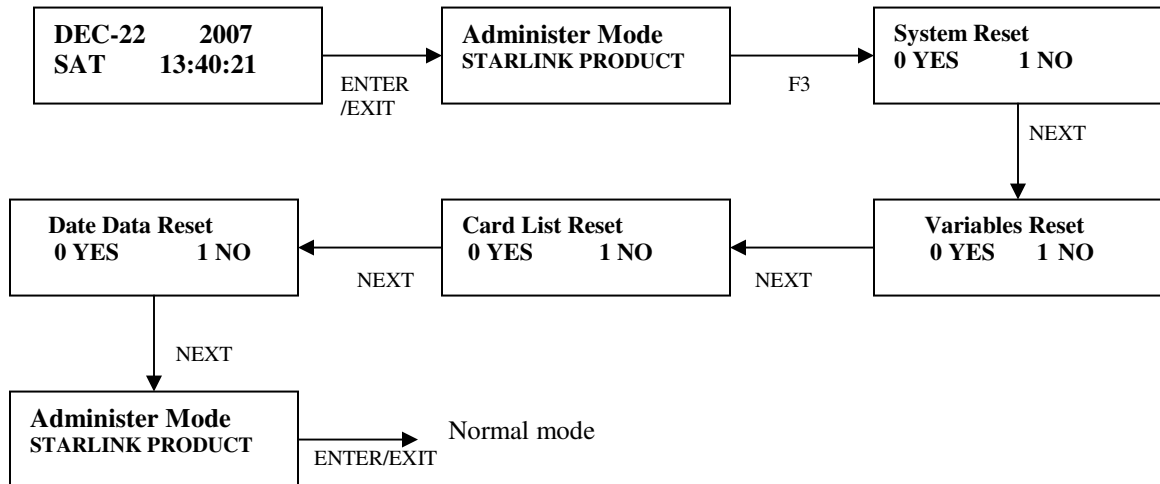

Figure 7: Sequence of Operation of Key F2 in Administer Mode

i. System Reset

You can reset the whole system through this option.

If press key “0”, system will reset and all data will be deleted.

If press key “1”, system will not reset.

ii. Variable Reset

If you press key “0” variables of machine will be deleted.

If you press key “1” variables of machine will not be deleted.

iii. Card List Reset

You can delete card list only.

If you press key “0”, list will be erased.

If you press key “1”, cards list will not be erased

iv. Date Data Reset

You can use this option to delete the punching data from the machine.

If we press key “0”, punching data will be erased.

If we press key “1”, punching data will not be erased.

4.2.4. Functionalities of key F4

These functional key is used for enroll the finger and delete the finger with respect to card.

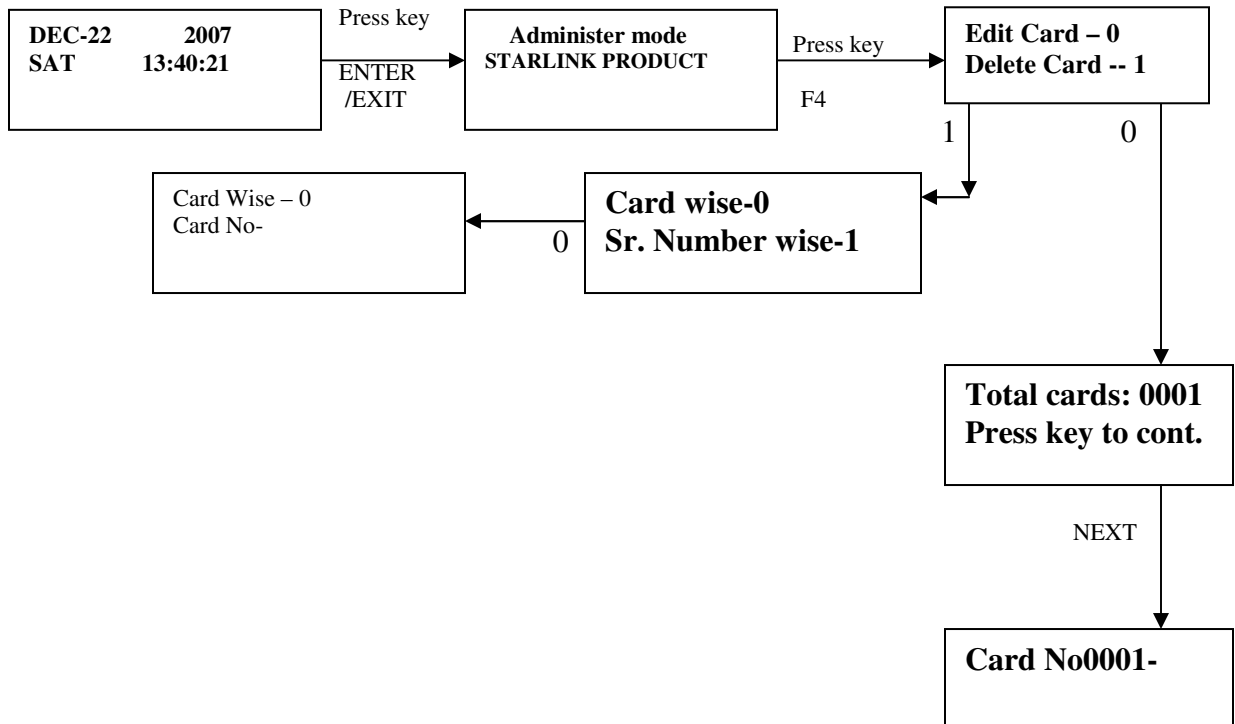

Figure 8: Sequence Operation of Enroll Finger Card /Delete Finger with respect to Card

i. Enroll the finger:

- Enter key “ENTER/EXIT” to switch to administer mode.
- Press key “F4” to switch to the enroll finger and delete finger.
- Press key 0 to enroll the finger. LCD display shows number of finger with respect to card have been registered in the machine

**TOTAL CARDS: 0004
Press Key to cont**

Press key “NEXT” to switch the next operation.

- Enter the card number, you want to enroll finger with respect to that card.

**Card No0001-
To Enroll - NEXT**

- Press key NEXT , LCD display shows

**REGISTER FINGER
0 YES 1 NO**

Press key 0 to register the finger

**Put finger!!!
0 YES 1 NO**

Now put the finger on the sensor and remove it, LCD display shows

**PUT FINGER!!!
SCAN SUCCESS**

Now again put finger on the sensor, LCD display shows

**PUT FINGER!!!
SUCCESS**

When process is complete, LCD display shows

**DONE!!
SUCCESS**

ii. Delete the card:

- Enter key “ENTER/EXIT” to switch to administer mode.
- Press key “F4” to switch to the enroll finger and delete finger.
- Press key 1 to delete finger with respect to card. LCD display shows

**Card wise – 0
Sr. Number wise --1**

You can delete the card through card number and sr. number wise.
If you press key “0”, LCD display shows

**Card wise - - 0
Card No. --**

Enter the card number and press key “NEXT” to delete finger with respect to that card.

**Card wise - -
Wait!!!**

That finger has been deleted.